



PERCONA
LIVE

Apr, 2016

Linux Systems Performance

Brendan Gregg
Senior Performance Architect

NETFLIX

Systems Performance in 50 mins



NETFLIX

REGIONS WHERE NETFLIX IS AVAILABLE

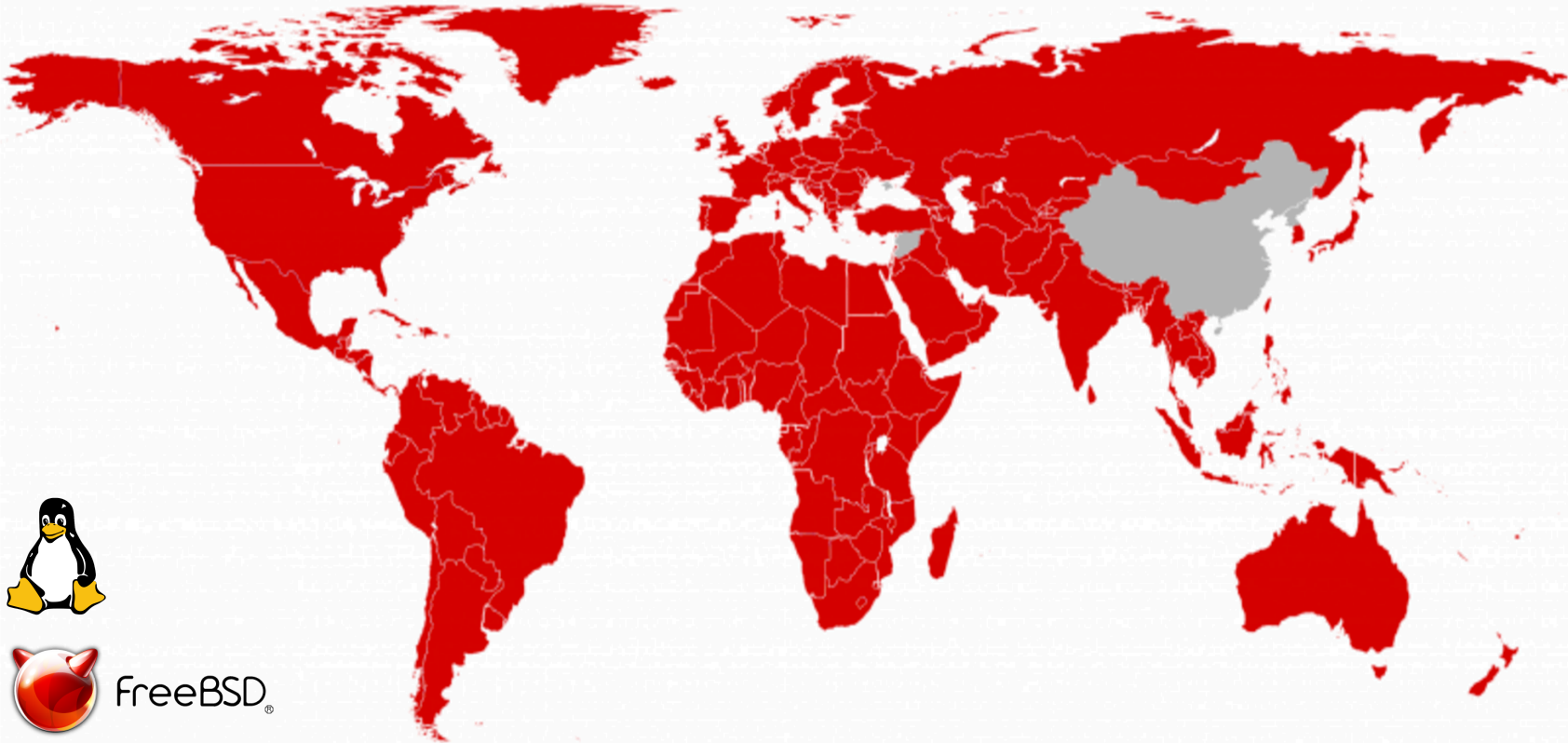

freeBSD®

Agenda

A brief discussion of 6 facets of Linux performance:

1. Observability
2. Methodologies
3. Benchmarking
4. Profiling
5. Tracing
6. Tuning

Audience: Everyone (DBAs, developers, operations, ...)

1. Observability

How do you measure these?

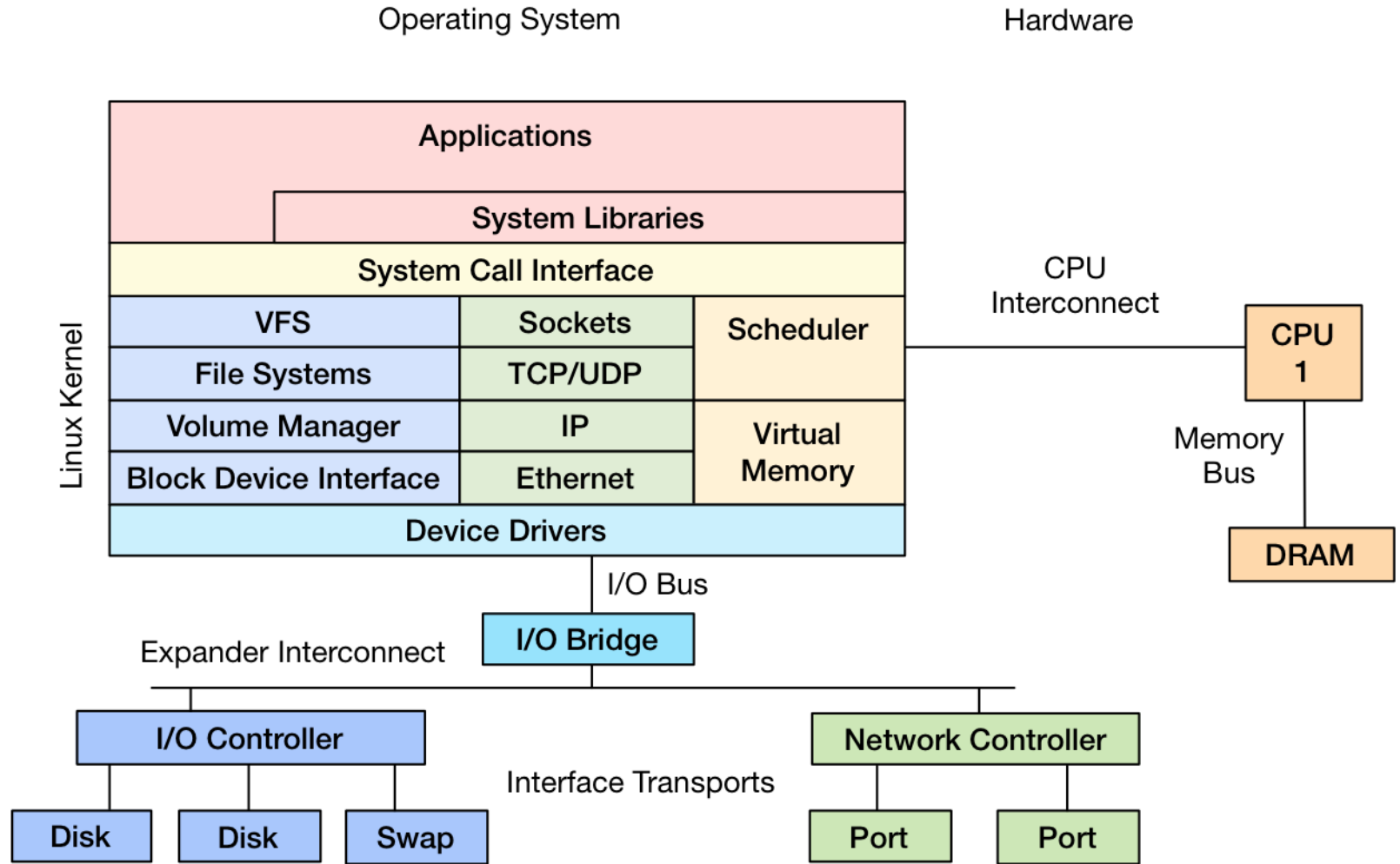

Observability Tools

- Tools showcase common metrics
 - Learning Linux tools is useful even if you never use them: the same metrics are in GUIs
- We usually use these metrics via:
 - Netflix Atlas: cloud-wide monitoring
 - Netflix Vector: instance analysis
- Linux has many tools
 - Plus many extra kernel sources of data that lack tools, are harder to use, and are practically undocumented
- Some tool examples...

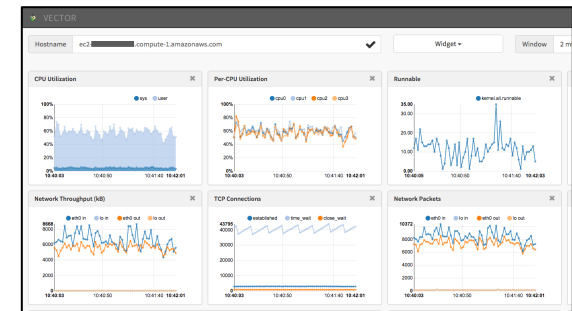

uptime

- One way to print *load averages*:

```
$ uptime  
07:42:06 up 8:16, 1 user, load average: 2.27, 2.84, 2.91
```

- A measure of resource demand: CPUs + disks
 - Other OSes only show CPUs: easier to interpret
- Exponentially-damped moving averages
- Time constants of 1, 5, and 15 minutes
 - Historic trend without the line graph
- Load > # of CPUs, may mean CPU saturation
 - Don't spend more than 5 seconds studying these

top (or htop)

- System and per-process interval summary:

```
$ top - 18:50:26 up 7:43, 1 user, load average: 4.11, 4.91, 5.22
Tasks: 209 total, 1 running, 206 sleeping, 0 stopped, 2 zombie
Cpu(s): 47.1%us, 4.0%sy, 0.0%ni, 48.4%id, 0.0%wa, 0.0%hi, 0.3%si, 0.2%st
Mem: 70197156k total, 44831072k used, 25366084k free, 36360k buffers
Swap: 0k total, 0k used, 0k free, 11873356k cached
```

PID	USER	PR	NI	VIRT	RES	SHR	S	%CPU	%MEM	TIME+	COMMAND
5738	apiproduct	20	0	62.6g	29g	352m	S	417	44.2	2144:15	java
1386	apiproduct	20	0	17452	1388	964	R	0	0.0	0:00.02	top
1	root	20	0	24340	2272	1340	S	0	0.0	0:01.51	init
2	root	20	0	0	0	0	S	0	0.0	0:00.00	kthreadd

[...]

- %CPU is summed across all CPUs
- Can miss short-lived processes (atop won't)
- Can consume noticeable CPU to read /proc

htop

1 [|||||] 53.6%
2 [|||||] 53.9%
Mem [|||||] 489/7450MB
Swp [|||||] 0/0MB

Tasks: 75, 55 thr; 1 running
Load average: 0.80 0.26 0.12
Uptime: 11 days, 08:47:52

PID	USER	PRI	NI	VIRT	RES	SHR	S	CPU%	MEM%	TIME+	Command
21162	root	20	0	22672	5216	1720	S	39.0	0.1	0:12.42	-bash
21542	root	20	0	24972	2608	1428	R	1.0	0.0	0:00.56	htop
1374	snmp	20	0	48320	4628	2352	S	0.0	0.1	1:17.87	/usr/sbin/snmpd -
1	root	20	0	24332	2260	1340	S	0.0	0.0	0:00.44	/sbin/init
335	root	20	0	17236	640	452	S	0.0	0.0	0:00.05	upstart-udev-brid
340	root	20	0	21596	1300	800	S	0.0	0.0	0:00.04	/sbin/udev --dae
368	messagebu	20	0	23820	944	640	S	0.0	0.0	0:00.04	dbus-daemon --sys
421	root	20	0	21460	736	340	S	0.0	0.0	0:00.00	/sbin/udev --dae
422	root	20	0	21460	736	340	S	0.0	0.0	0:00.00	/sbin/udev --dae
530	root	20	0	15192	392	196	S	0.0	0.0	0:00.00	upstart-socket-br
604	root	20	0	7268	1028	532	S	0.0	0.0	0:00.01	dhclient3 -e IF_M
703	postfix	20	0	27176	1616	1316	S	0.0	0.0	0:00.01	pickup -l -t fifo
770	root	20	0	14508	976	812	S	0.0	0.0	0:00.00	/sbin/getty -8 38
775	root	20	0	14508	980	812	S	0.0	0.0	0:00.00	/sbin/getty -8 38
780	root	20	0	14508	976	812	S	0.0	0.0	0:00.00	/sbin/getty -8 38
781	root	20	0	14508	980	812	S	0.0	0.0	0:00.00	/sbin/getty -8 38

F1 Help F2 Setup F3 Search F4 Filter F5 Tree F6 SortBy F7 Nice -F8 Nice +F9 Kill F10 Quit

vmstat

- Virtual memory statistics and more:

```
$ vmstat -Sm 1
```

```
procs  -----memory-----  ---swap--  ----io----  -system--  ----cpu----  
 r   b   swpd   free   buff   cache   si   so   bi   bo   in   cs   us   sy   id   wa  
 8   0     0   1620   149   552     0   0    1  179   77   12  25  34   0   0  
 7   0     0   1598   149   552     0   0    0    0  205  186  46  13   0   0  
 8   0     0   1617   149   552     0   0    0    8  210  435  39  21   0   0  
 8   0     0   1589   149   552     0   0    0    0  218  219  42  17   0   0  
[...]
```

- USAGE: vmstat [interval [count]]
- First output line has *some* summary since boot values
 - Should be all; partial is confusing
- High level CPU summary
 - “r” is runnable tasks

iostat

- Block I/O (disk) stats. 1st output is since boot.

```
$ iostat -xmdz 1
```

```
Linux 3.13.0-29 (db001-eb883efa) 08/18/2014 _x86_64_ (16 CPU)
```

Device:	rrqm/s	wrqm/s	r/s	w/s	rMB/s	wMB/s	\ ...
xvda	0.00	0.00	0.00	0.00	0.00	0.00	/ ...
xvdb	213.00	0.00	15299.00	0.00	338.17	0.00	\ ...
xvdc	129.00	0.00	15271.00	3.00	336.65	0.01	/ ...
md0	0.00	0.00	31082.00	3.00	678.45	0.01	\ ...

Workload 

- Very useful set of stats

...	\	avgqu-sz	await	r_await	w_await	svctm	%util
...	/	0.00	0.00	0.00	0.00	0.00	0.00
...	\	126.09	8.22	8.22	0.00	0.06	86.40
...	/	99.31	6.47	6.47	0.00	0.06	86.00
...	\	0.00	0.00	0.00	0.00	0.00	0.00

Resulting Performance 

free

- Main memory usage:

```
$ free -m
```

	total	used	free	shared	buffers	cached
Mem:	3750	1111	2639	0	147	527
-/+ buffers/cache:		436	3313			
Swap:	0	0	0			

- buffers: block device I/O cache
- cached: virtual page cache

strace

- System call tracer:

```
$ strace -tttT -p 313
1408393285.779746 getgroups(0, NULL)      = 1 <0.000016>
1408393285.779873 getgroups(1, [0])     = 1 <0.000015>
1408393285.780797 close(3)           = 0 <0.000016>
1408393285.781338 write(1, "LinuxCon 2014!\n", 15LinuxCon 2014!
) = 15 <0.000048>
```

- Eg, -ttt: time (us) since epoch; -T: syscall time (s)
- Translates syscall args
 - Very helpful for solving system usage issues
- Currently has massive overhead (ptrace based)
 - Can slow the target by > 100x. Use extreme caution.

tcpdump

- Sniff network packets for post analysis:

```
$ tcpdump -i eth0 -w /tmp/out.tcpdump
tcpdump: listening on eth0, link-type EN10MB (Ethernet), capture size 65535 bytes
^C7985 packets captured
8996 packets received by filter
1010 packets dropped by kernel
# tcpdump -nr /tmp/out.tcpdump | head
reading from file /tmp/out.tcpdump, link-type EN10MB (Ethernet)
20:41:05.038437 IP 10.44.107.151.22 > 10.53.237.72.46425: Flags [P.], seq 18...
20:41:05.038533 IP 10.44.107.151.22 > 10.53.237.72.46425: Flags [P.], seq 48...
20:41:05.038584 IP 10.44.107.151.22 > 10.53.237.72.46425: Flags [P.], seq 96...
[...]
```

- Study packet sequences with timestamps (us)
- CPU overhead optimized (socket ring buffers), but can still be significant. Use caution.

netstat

- Various network protocol statistics using -s:
- A multi-tool:
 - i: interface stats
 - r: route table
 - default: list conns
- netstat -p: shows process details!
- Per-second interval with -c

```
$ netstat -s
[...]
Tcp:
  736455 active connections openings
  176887 passive connection openings
  33 failed connection attempts
  1466 connection resets received
  3311 connections established
  91975192 segments received
  180415763 segments send out
  223685 segments retransmitted
  2 bad segments received.
  39481 resets sent

[...]
TcpExt:
  12377 invalid SYN cookies received
  2982 delayed acks sent

[...]
```

slabtop

- Kernel slab allocator memory usage:

```
$ slabtop
```

```
Active / Total Objects (% used) : 4692768 / 4751161 (98.8%)
Active / Total Slabs (% used)    : 129083 / 129083 (100.0%)
Active / Total Caches (% used)   : 71 / 109 (65.1%)
Active / Total Size (% used)     : 729966.22K / 738277.47K (98.9%)
Minimum / Average / Maximum Object : 0.01K / 0.16K / 8.00K
```

OBJS	ACTIVE	USE	OBJ	SIZE	SLABS	OBJ/SLAB	CACHE	SIZE	NAME
3565575	3565575	100%	0.10K	91425	39	365700K	buffer_head		
314916	314066	99%	0.19K	14996	21	59984K	dentry		
184192	183751	99%	0.06K	2878	64	11512K	kmalloc-64		
138618	138618	100%	0.94K	4077	34	130464K	xfs_inode		
138602	138602	100%	0.21K	3746	37	29968K	xfs_ili		
102116	99012	96%	0.55K	3647	28	58352K	radix_tree_node		
97482	49093	50%	0.09K	2321	42	9284K	kmalloc-96		
22695	20777	91%	0.05K	267	85	1068K	shared_policy_node		
21312	21312	100%	0.86K	576	37	18432K	ext4_inode_cache		
16288	14601	89%	0.25K	509	32	4072K	kmalloc-256		

```
[...]
```

pcstat

- Show page cache residency by file:

```
# ./pcstat data0*
```

Name	Size	Pages	Cached	Percent
data00	104857600	25600	25600	100.000
data01	104857600	25600	25600	100.000
data02	104857600	25600	4080	015.938
data03	104857600	25600	25600	100.000
data04	104857600	25600	16010	062.539
data05	104857600	25600	0	000.000

- Uses the mincore(2) syscall. Useful for database performance analysis.

perf_events

- Provides the "perf" command
- In Linux source code: tools/perf
 - Usually pkg added by linux-tools-common, etc.
- **Multi-tool** with many capabilities
 - CPU profiling
 - PMC profiling
 - Static & dynamic tracing
- *Covered later in Profiling & Tracing*

Where do you start?...and stop?

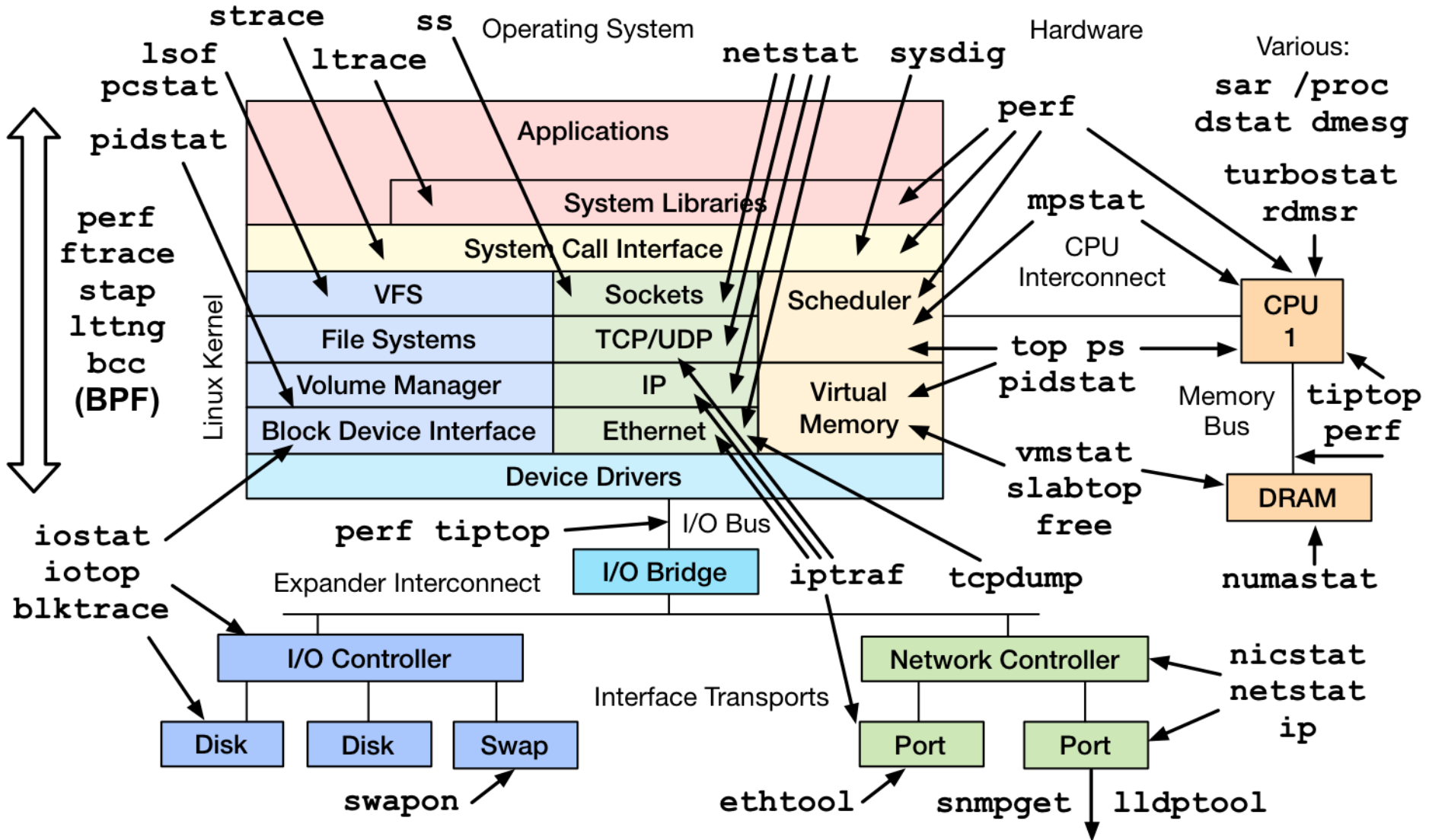

2. Methodologies

Anti-Methodologies

- The lack of a deliberate methodology...
- Street Light Anti-Method:
 - 1. Pick observability tools that are
 - Familiar
 - Found on the Internet
 - Found at random
 - 2. Run tools
 - 3. Look for obvious issues
- Drunk Man Anti-Method:
 - Tune things at random until the problem goes away

Methodologies

- Linux Performance Analysis in 60 seconds
- The USE method
- CPU Profile Method
- Resource Analysis
- Workload Analysis
- Others include:
 - Workload characterization
 - Drill-down analysis
 - Off-CPU analysis
 - Static performance tuning
 - 5 whys
 - ...

Linux Perf Analysis in 60s

1. `uptime`
2. `dmesg | tail`
3. `vmstat 1`
4. `mpstat -P ALL 1`
5. `pidstat 1`
6. `iostat -xz 1`
7. `free -m`
8. `sar -n DEV 1`
9. `sar -n TCP,ETCP 1`
10. `top`

Linux Perf Analysis in 60s

1. `uptime` -----▶ load averages
2. `dmesg | tail` -----▶ kernel errors
3. `vmstat 1` -----▶ overall stats by time
4. `mpstat -P ALL 1` -----▶ CPU balance
5. `pidstat 1` -----▶ process usage
6. `iostat -xz 1` -----▶ disk I/O
7. `free -m` -----▶ memory usage
8. `sar -n DEV 1` -----▶ network I/O
9. `sar -n TCP,ETCP 1` -----▶ TCP stats
10. `top` -----▶ check overview

<http://techblog.netflix.com/2015/11/linux-performance-analysis-in-60s.html>

The USE Method

- For every resource, check:

1. **Utilization**
2. **Saturation**
3. **Errors**

- Definitions:

- Utilization: busy time
- Saturation: queue length or queued time
- Errors: easy to interpret (objective)

- Helps if you have a functional (block) diagram of your system / software / environment, showing all resources

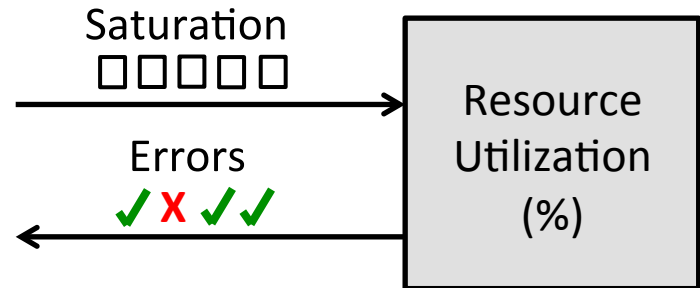

Start with the questions, then find the tools

USE Method for Hardware

- For every resource, check:
 1. **Utilization**
 2. **Saturation**
 3. **Errors**
- Including busses & interconnects

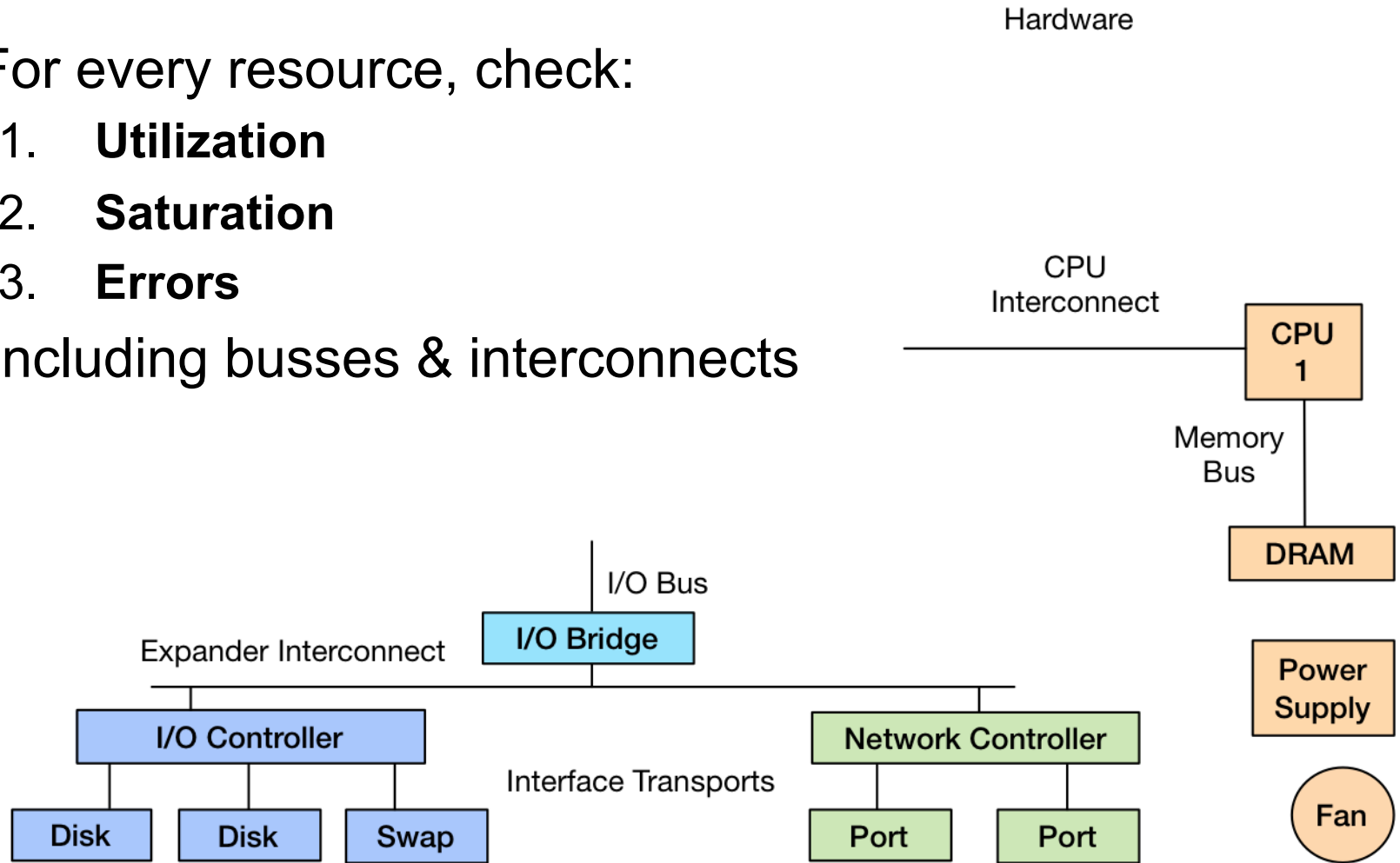

USE Method: Linux Performance Checklist

The [USE Method](#) provides a strategy for performing a complete check of system health, identifying common bottlenecks and errors. For each system resource, metrics for utilization, saturation and errors are identified and checked. Any issues discovered are then investigated using further strategies.

This is an example USE-based metric list for Linux operating systems (eg, Ubuntu, CentOS, Fedora). This is primarily intended for system administrators of the physical systems, who are using command line tools. Some of these metrics can be found in remote monitoring tools.

Physical Resources [\(http://www.brendangregg.com/USEmethod/use-linux.html\)](http://www.brendangregg.com/USEmethod/use-linux.html)

component	type	metric
CPU	utilization	system-wide: <code>vmstat 1, "us" + "sy" + "st"; sar -u</code> , sum fields except "%idle" and "%iowait"; <code>dstat -c</code> , sum fields except "idl" and "wai"; per-cpu: <code>mpstat -P ALL 1</code> , sum fields except "%idle" and "%iowait"; <code>sar -P ALL</code> , same as <code>mpstat</code> ; per-process: <code>top, "%CPU"; htop, "CPU%"; ps -o pcpu; pidstat 1, "%CPU"; per-kernel-thread: top/htop ("K" to toggle), where VIRT == 0 (heuristic). [1]</code>
CPU	saturation	system-wide: <code>vmstat 1, "r" > CPU count [2]; sar -g, "runq-sz" > CPU count; dstat -p, "run" > CPU count; per-process: /proc/PID/schedstat 2nd field (sched_info.run_delay); perf sched latency (shows "Average" and "Maximum" delay per-schedule); dynamic tracing, eg, SystemTap schedtimes.stp "queued(us)" [3]</code>
CPU	errors	<code>perf (LPE)</code> if processor specific error events (CPC) are available; eg, AMD64's "04Ah Single-bit ECC Errors Recorded by Scrubber" [4]
Memory capacity	utilization	system-wide: <code>free -m, "Mem:" (main memory), "Swap:" (virtual memory); vmstat 1, "free" (main memory), "swap" (virtual memory); sar -r, "%memused"; dstat -m, "free"; slabtop -s c</code> for kmem slab usage; per-process: <code>top/htop, "RES" (resident main memory), "VIRT" (virtual memory), "Mem" for system-wide summary</code>
Memory capacity	saturation	system-wide: <code>vmstat 1, "si"/"so" (swapping); sar -B, "pgscank" + "pgscand" (scanning); sar -W; per-process: 10th field (minflt) from /proc/PID/stat for minor-fault rate, or dynamic tracing [5]; OOM killer: <code>dmesg grep killed</code></code>
Memory capacity	errors	<code>dmesg</code> for physical failures; dynamic tracing, eg, SystemTap uprobes for failed <code>malloc()</code> s
Network Interfaces	utilization	<code>sar -n DEV 1, "rxKB/s"/max "txKB/s"/max; ip -s link, RX/TX tput / max bandwidth; /proc/net/dev, "bytes" RX/TX tput/max; nicstat "%Util" [6]</code>

CPU Profile Method

1. Take a CPU profile
2. Understand all software in profile > 1%
 - Discovers a wide range of issues by their CPU usage
 - Directly: CPU consumers
 - Indirectly: initialization of I/O, locks, times, ...

- Narrows target of study to only its running components

Flame Graph

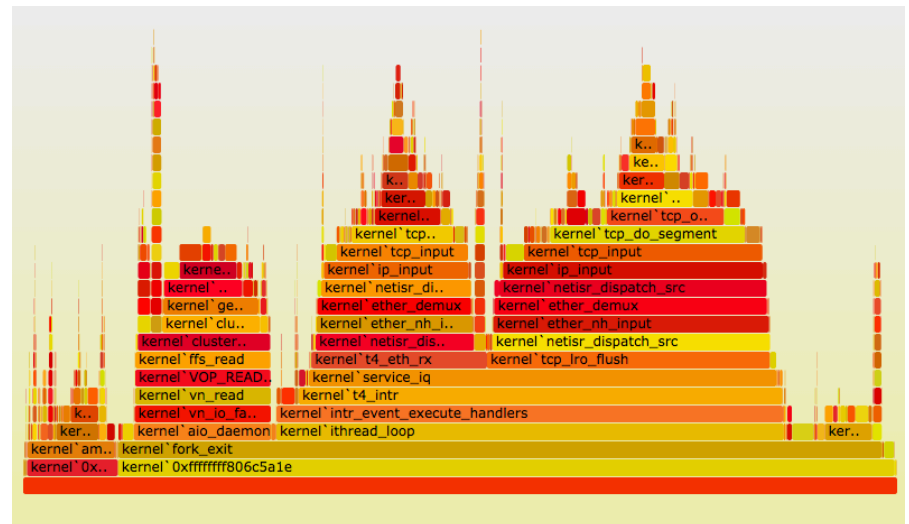

Resource Analysis

- Typical approach for system performance analysis: begin with system tools & metrics
- Pros:
 - Generic
 - Aids resource perf tuning
- Cons:
 - Uneven coverage
 - False positives

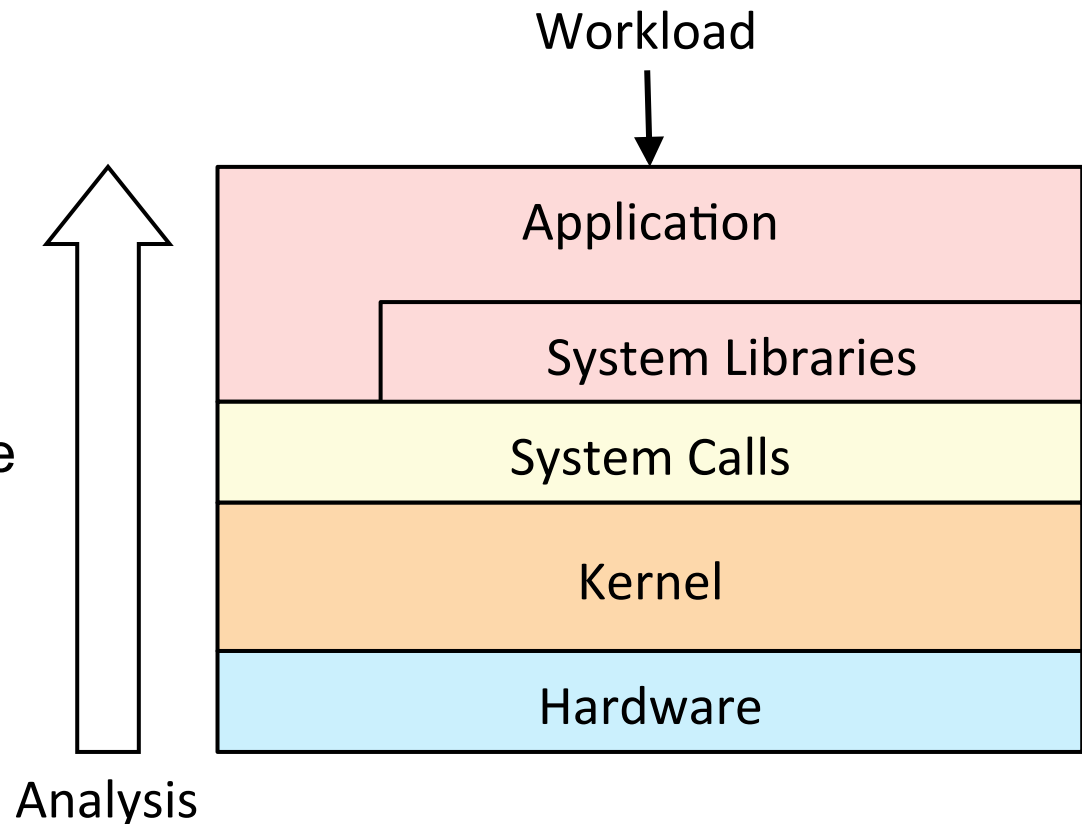

Workload Analysis

- Begin with application metrics & context
- Pros:
 - Accurate, proportional metrics
 - App context
- Cons:
 - App specific
 - Difficult to dig from app to resource

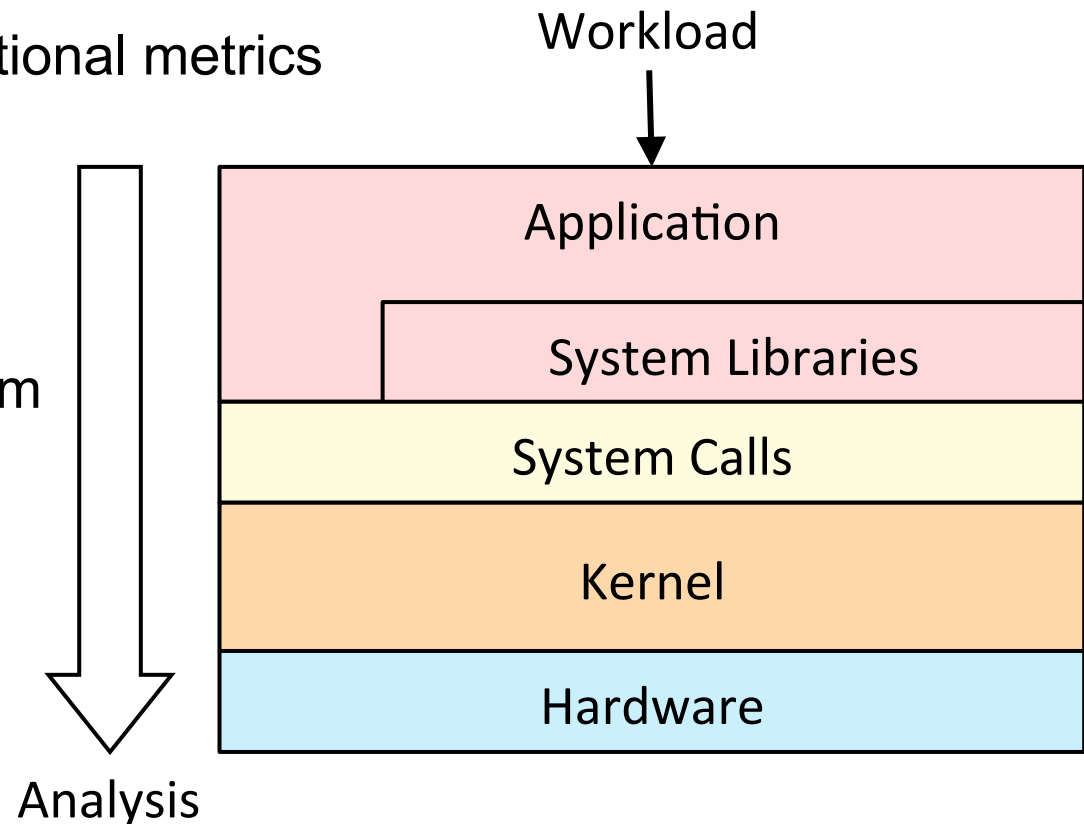

3. Benchmarking

**~100% of benchmarks are
wrong**

Benchmarking

- Apart from observational analysis, benchmarking is a useful form of experimental analysis
 - Try observational first; benchmarks can perturb
- However, benchmarking is **error prone**:
 - Testing the wrong target: eg, FS cache instead of disk
 - Choosing the wrong target: eg, disk instead of FS cache ... doesn't resemble real world usage
 - Invalid results: eg, bugs
 - Misleading results: you benchmark A, but actually measure B, and conclude you measured C
- The energy needed to refute benchmarks is multiple orders of magnitude bigger than to run them

Benchmark Examples

- Micro benchmarks:
 - File system maximum cached read operations/sec
 - Network maximum throughput
- Macro (application) benchmarks:
 - Simulated application maximum request rate
- Bad benchmarks:
 - getpid() in a tight loop
 - Context switch timing

The Benchmark Paradox

- Benchmarking is used for product evaluations
 - Eg, evaluating cloud vendors
- The Benchmark Paradox:
 - If your product's chances of winning a benchmark are 50/50, you'll usually lose
 - <http://www.brendangregg.com/blog/2014-05-03/the-benchmark-paradox.html>
- Solving this seeming paradox (and benchmarking in general)...

For any given benchmark result,
ask:
why isn't it 10x?

Active Benchmarking

- Root cause performance analysis **while the benchmark is still running**
 - Use the earlier observability tools
 - Identify the limiter (or suspected limiter) and include it with the benchmark results
 - Answer: why not 10x?
- This takes time, but uncovers most mistakes

4. Profiling

Profiling

- Can you do this?

“As an experiment to investigate the performance of the resulting TCP/IP implementation ... the [redacted] is CPU saturated, but the [redacted] has about 30% idle time. The time spent in the system processing the data is spread out among handling for the Ethernet (20%), IP packet processing (10%), TCP processing (30%), checksumming (25%), and user system call handling (15%), with no single part of the handling dominating the time in the system.”

Profiling

- Can you do this?

“As an experiment to investigate the performance of the resulting TCP/IP implementation ... the 11/750 is CPU saturated, but the 11/780 has about 30% idle time. The time spent in the system processing the data is spread out among handling for the Ethernet (20%), IP packet processing (10%), TCP processing (30%), checksumming (25%), and user system call handling (15%), with no single part of the handling dominating the time in the system.”

– Bill Joy, **1981**, TCP-IP Digest, Vol 1 #6

<https://www.rfc-editor.org/rfc/museum/tcp-ip-digest/tcp-ip-digest.v1n6.1>

perf_events

- Introduced earlier: multi-tool, profiler. Provides "perf".

```
usage: perf [--version] [--help] [OPTIONS] COMMAND [ARGS]
```

The most commonly used perf commands are:

annotate	Read perf.data (created by perf record) and display annotated code
archive	Create archive with object files with build-ids found in perf.data file
bench	General framework for benchmark suites
buildid-cache	Manage build-id cache.
buildid-list	List the buildids in a perf.data file
data	Data file related processing
diff	Read perf.data files and display the differential profile
evlist	List the event names in a perf.data file
inject	Filter to augment the events stream with additional information
kmem	Tool to trace/measure kernel memory(slab) properties
kvm	Tool to trace/measure kvm guest os
list	List all symbolic event types
lock	Analyze lock events
mem	Profile memory accesses
record	Run a command and record its profile into perf.data
report	Read perf.data (created by perf record) and display the profile
sched	Tool to trace/measure scheduler properties (latencies)
script	Read perf.data (created by perf record) and display trace output
stat	Run a command and gather performance counter statistics
test	Runs sanity tests.
timechart	Tool to visualize total system behavior during a workload
top	System profiling tool.
trace	strace inspired tool
probe	Define new dynamic tracepoints

See 'perf help COMMAND' for more information on a specific command.

perf_events: CPU profiling

- Sampling full stack traces at 99 Hertz, for 30 secs:

```
# perf record -F 99 -ag -- sleep 30
[ perf record: Woken up 9 times to write data ]
[ perf record: Captured and wrote 2.745 MB perf.data (~119930 samples) ]
# perf report -n --stdio
1.40%    162          java [kernel.kallsyms]          [k] _raw_spin_lock
      |
      --- _raw_spin_lock
          |
          --63.21%-- try_to_wake_up
              |
              --63.91%-- default_wake_function
                  |
                  --56.11%-- __wake_up_common
                      __wake_up_locked
                      ep_poll_callback
                      __wake_up_common
                      __wake_up_sync_key
                          |
                          |--59.19%-- sock_def_readable

[...78,000 lines truncated...]
```

perf_events: Full "report" Output

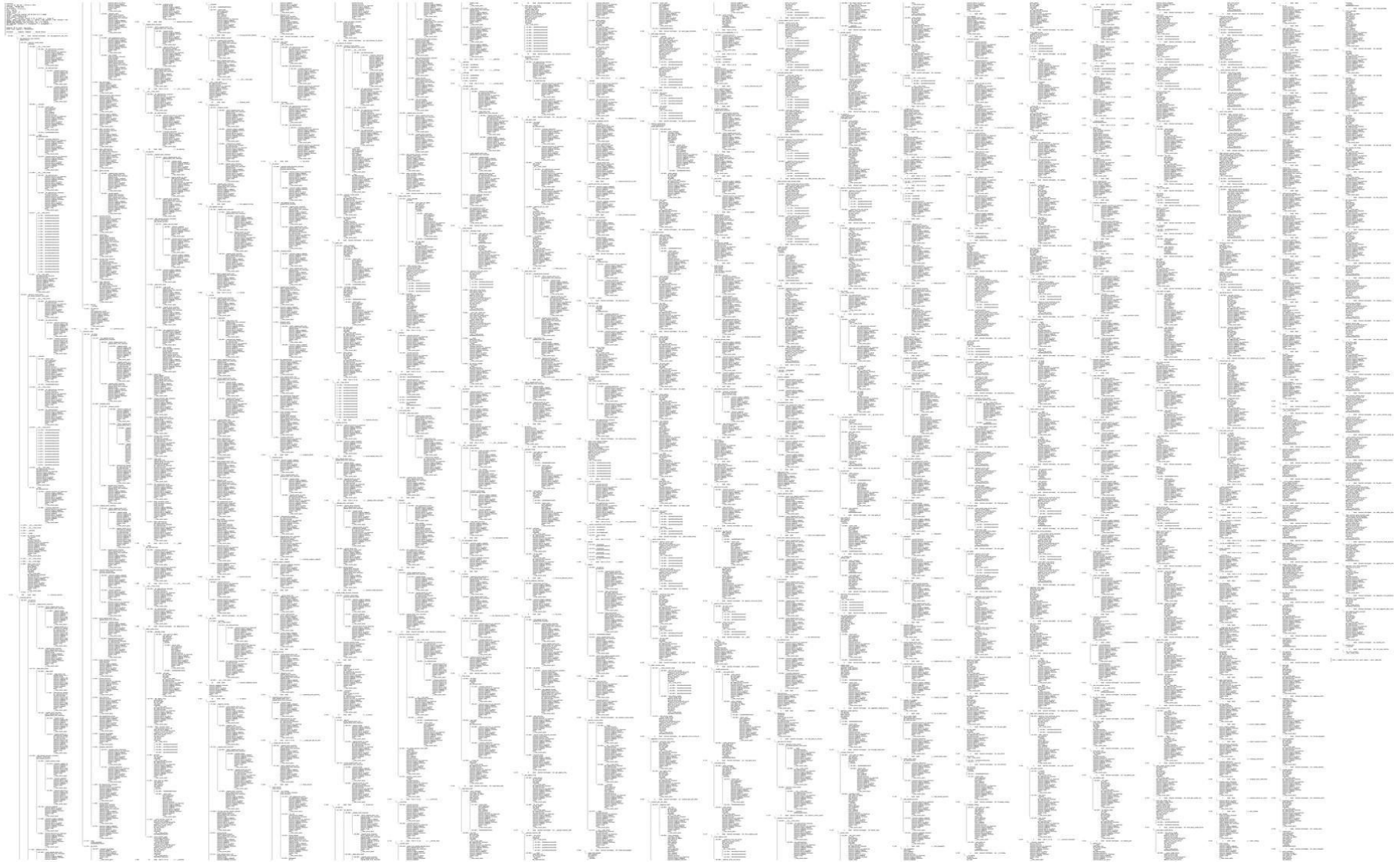

... as a Flame Graph

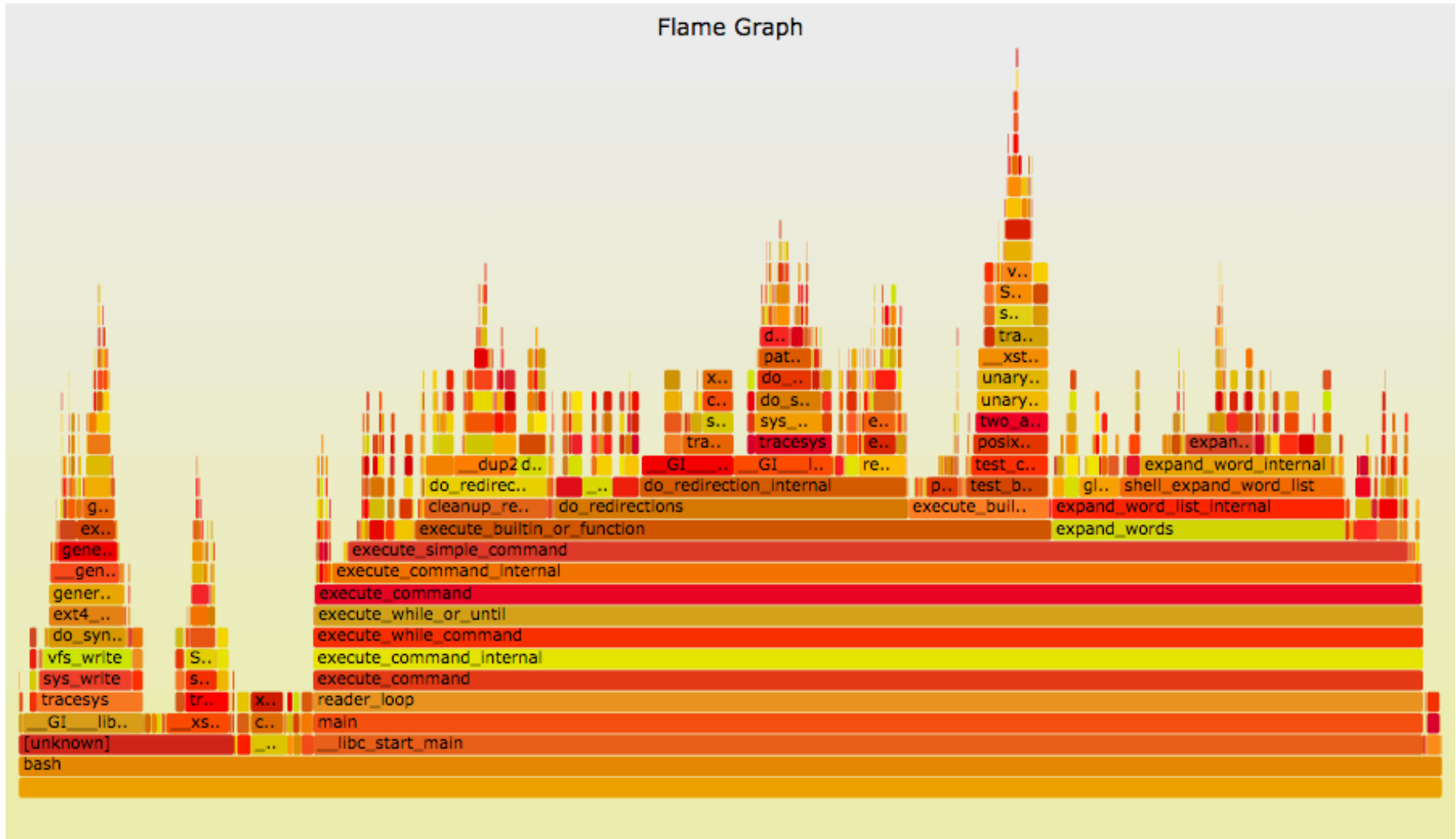

perf_events: Flame Graphs

```
git clone --depth 1 https://github.com/brendangregg/FlameGraph
cd FlameGraph
perf record -F 99 -a -g -- sleep 30
perf script | ./stackcollapse-perf.pl | ./flamegraph.pl > perf.svg
```

- Flame Graphs:
 - **x-axis**: alphabetical stack sort, to maximize merging
 - **y-axis**: stack depth
 - **color**: random, or hue can be a dimension (eg, diff)
- Interpretation:
 - top edge is on-CPU, beneath it is ancestry
- Easy to get working
 - <http://www.brendangregg.com/FlameGraphs/cpuflamegraphs.html>
- Also in Mar/Apr issue of ACMQ

- The first ever flame graph was generated for MySQL
- This background is the output of a DTrace CPU profile, which only printed unique stacks with counts

◻ ← Size of
one stack

perf_events: Workflow

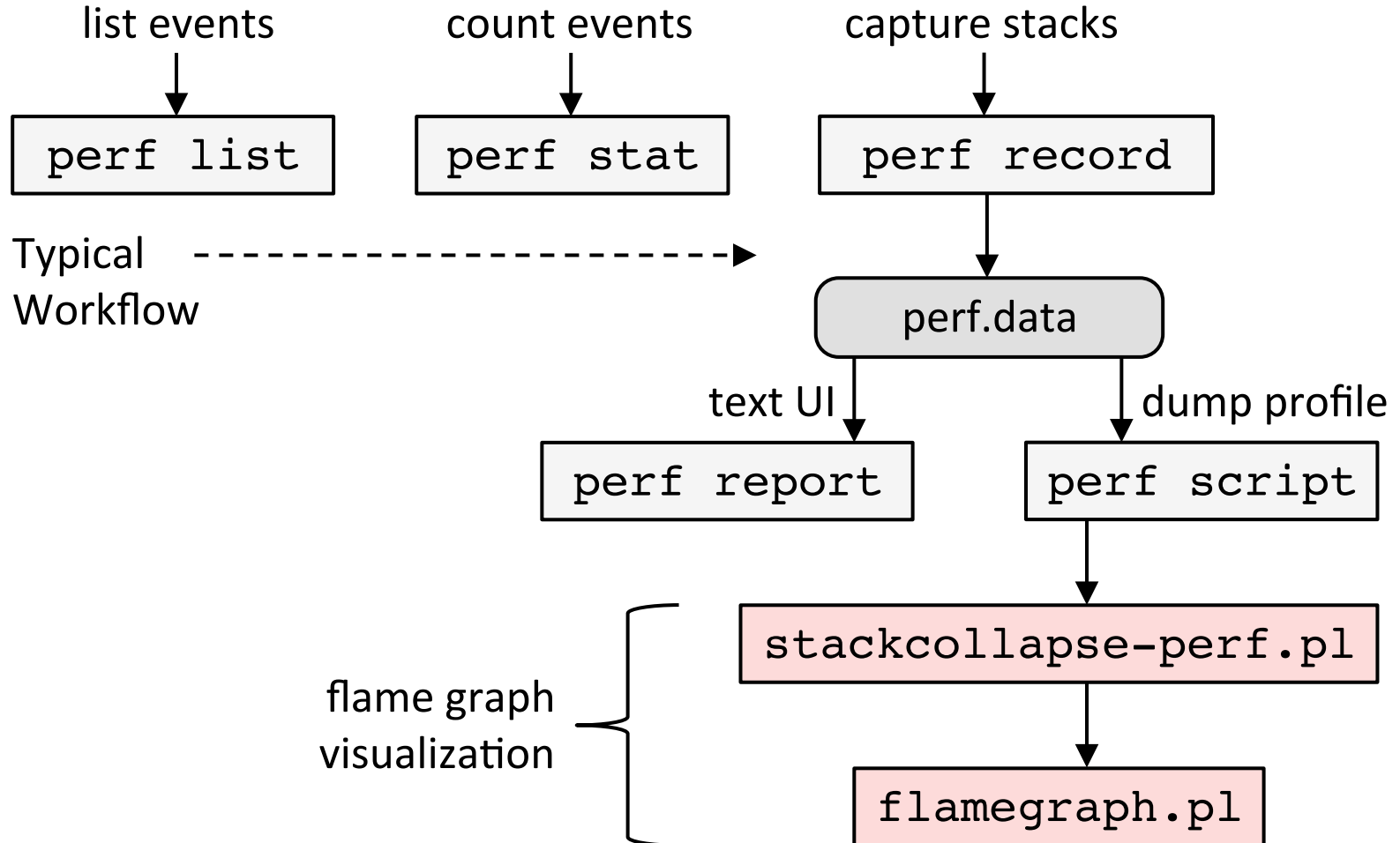

perf_events: Counters

- Performance Monitoring Counters (PMCs):

```
$ perf list | grep -i hardware
cpu-cycles OR cycles [Hardware event]
stalled-cycles-frontend OR idle-cycles-frontend [Hardware event]
stalled-cycles-backend OR idle-cycles-backend [Hardware event]
instructions [Hardware event]
[...]
branch-misses [Hardware event]
bus-cycles [Hardware event]
L1-dcache-loads [Hardware cache event]
L1-dcache-load-misses [Hardware cache event]
[...]
rNNN (see 'perf list --help' on how to encode it) [Raw hardware event ...]
mem:<addr>[:access] [Hardware breakpoint]
```

- Identify CPU cycle breakdowns, esp. stall types
- PMCs not enabled by-default in clouds (yet)
- Can be time-consuming to use (CPU manuals)

5. Tracing

Linux Event Sources

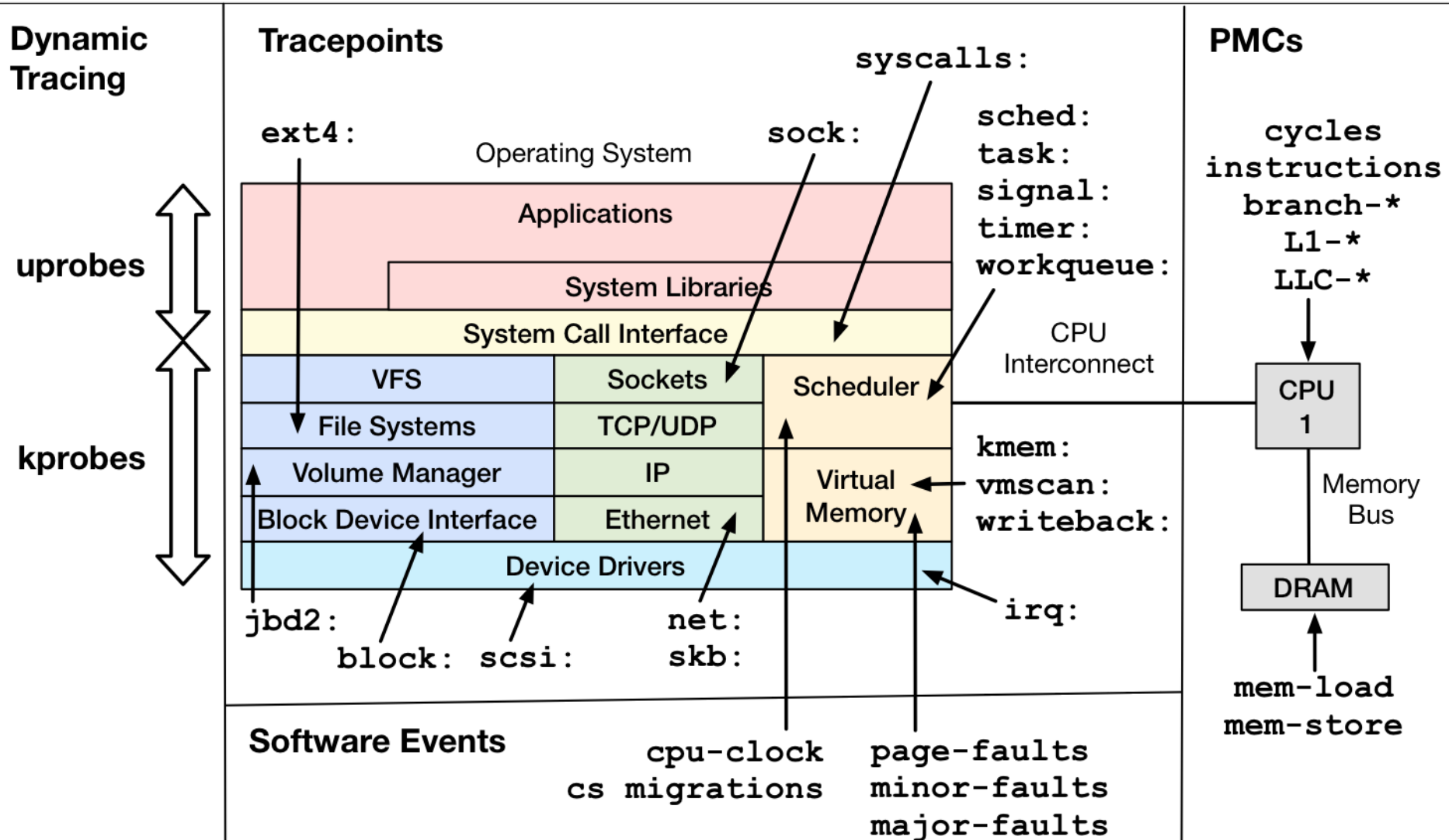

Tracing Stack

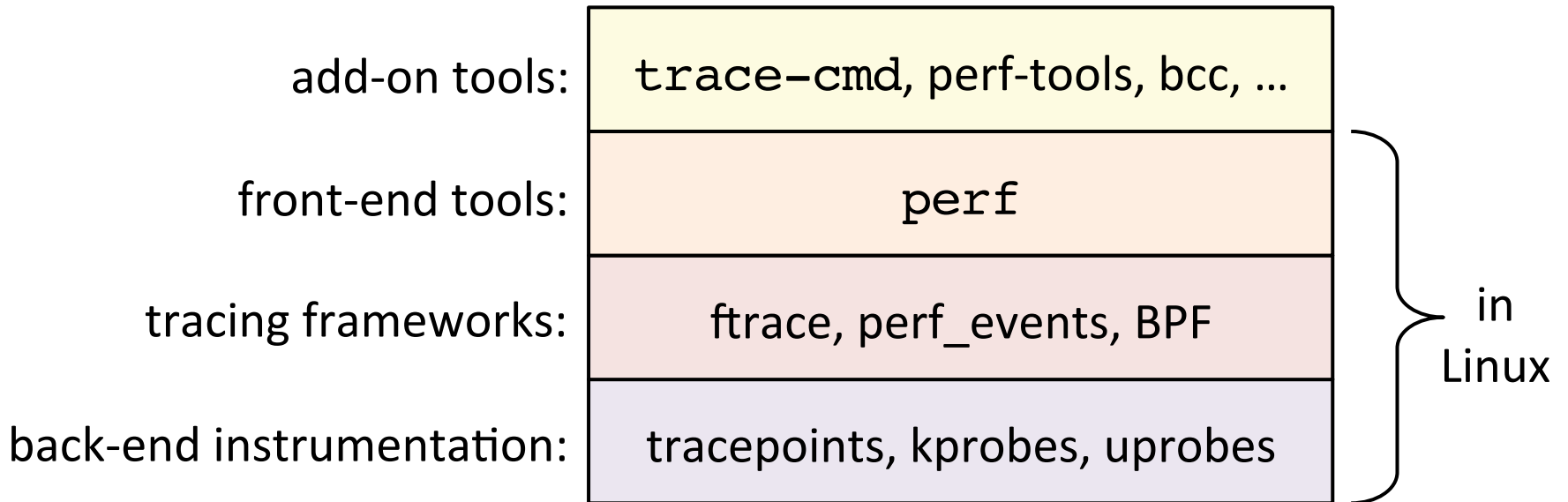

ftrace

- Added by Steven Rostedt and others since 2.6.27
 - CONFIG_FTRACE, CONFIG_FUNCTION_PROFILER, ...
 - See Linux source: Documentation/trace/ftrace.txt
 - A collection of powerful features, good for hacking
- Use directly via `/sys/kernel/debug/tracing` (not easy):

```
linux-4.0.0+# ls /sys/kernel/debug/tracing/  
available_events          max_graph_depth         stack_max_size  
available_filter_functions options                 stack_trace  
available_tracers        per_cpu                 stack_trace_filter  
buffer_size_kb           printk_formats          trace  
[...]
```

- Or via front-ends:
 - Steven's trace-cmd
 - my perf-tools: iosnoop, iolateness, funccount, kprobe, ...

ftrace: perf-tools iosnoop

- Block I/O (disk) events with latency:

```
# ./iosnoop -ts
Tracing block I/O. Ctrl-C to end.
STARTs          ENDS          COMM          PID   TYPE  DEV    BLOCK    BYTES  LATms
5982800.302061  5982800.302679  supervise    1809   W    202,1  17039600  4096   0.62
5982800.302423  5982800.302842  supervise    1809   W    202,1  17039608  4096   0.42
5982800.304962  5982800.305446  supervise    1801   W    202,1  17039616  4096   0.48
5982800.305250  5982800.305676  supervise    1801   W    202,1  17039624  4096   0.43
[...]
```

```
# ./iosnoop -h
USAGE: iosnoop [-hQst] [-d device] [-i iotype] [-p PID] [-n name] [duration]
          -d device          # device string (eg, "202,1)
          -i iotype         # match type (eg, '*R*' for all reads)
          -n name           # process name to match on I/O issue
          -p PID           # PID to match on I/O issue
          -Q                # include queueing time in LATms
          -s                # include start time of I/O (s)
          -t                # include completion time of I/O (s)
          -h                # this usage message
          duration         # duration seconds, and use buffers
[...]
```

ftrace: perf-tools iolateness

- Block I/O (disk) latency distributions:

```
# ./iolateness
```

```
Tracing block I/O. Output every 1 seconds. Ctrl-C to end.
```

>=(ms)	..	<(ms)	:	I/O	 	Distribution	
0	->	1	:	2104		#####	
1	->	2	:	280		#####	
2	->	4	:	2		#	
4	->	8	:	0			
8	->	16	:	202		####	

>=(ms)	..	<(ms)	:	I/O	 	Distribution	
0	->	1	:	1144		#####	
1	->	2	:	267		#####	
2	->	4	:	10		#	
4	->	8	:	5		#	
8	->	16	:	248		#####	
16	->	32	:	601		#####	
32	->	64	:	117		####	

```
[...]
```

ftrace: perf-tools funccount

- Count a kernel function call rate:

```
# ./funccount -i 1 'bio_*'  
Tracing "bio_*"... Ctrl-C to end.
```

FUNC	COUNT
bio_attempt_back_merge	26
bio_get_nr_vecs	361
bio_alloc	536
bio_alloc_bioset	536
bio_endio	536
bio_free	536
bio_fs_destructor	536
bio_init	536
bio_integrity_enabled	536
bio_put	729
bio_add_page	1004

Counts are in-kernel,
for low overhead

[...]

- -i: set an output interval (seconds), otherwise until Ctrl-C

ftrace: perf-tools uprobe

- Dynamically trace user-level functions; eg, MySQL:

```
# ./uprobe 'p:dispatch_command /opt/mysql/bin/mysqld:Z16dispatch_command19enum_server_commandP3THDPcj
+0(%dx):string'
Tracing uprobe dispatch_command (p:dispatch_command /opt/mysql/bin/mysqld:0x2dbd40 +0(%dx):string).
Ctrl-C to end.
mysql-2855 [001] d... 19956674.509085: dispatch_command: (0x6dbd40) arg1="show tables"
mysql-2855 [001] d... 19956675.541155: dispatch_command: (0x6dbd40) arg1="SELECT * FROM
numbers where number > 32000"
```

- Filter on string match; eg, "SELECT":

```
# ./uprobe 'p:dispatch_command /opt/mysql/bin/mysqld:Z16dispatch_command19enum_server_commandP3THDPcj
cmd=+0(%dx):string' 'cmd ~ "SELECT*"'
Tracing uprobe dispatch_command (p:dispatch_command /opt/mysql/bin/mysqld:0x2dbd40 cmd=
+0(%dx):string). Ctrl-C to end.
mysql-2855 [001] d... 19956754.619958: dispatch_command: (0x6dbd40) cmd="SELECT * FROM
numbers where number > 32000"
mysql-2855 [001] d... 19956755.060125: dispatch_command: (0x6dbd40) cmd="SELECT * FROM
numbers where number > 32000"
```

- Ok for hacking, but not friendly; need perf_events/BPF

perf_events

- Powerful profiler (covered earlier) and tracer:
 - User-level and kernel dynamic tracing
 - Kernel line tracing and local variables (debuginfo)
 - Kernel filtering expressions
 - Efficient in-kernel counts (perf stat)
- Intended as the official Linux tracer/profiler
- Becoming more programmable with BPF support (2016)
 - Search lkml for "perf" and "BPF"

perf_events: Listing Events

```
# perf list
cpu-cycles OR cycles           [Hardware event]
instructions                   [Hardware event]
cache-references              [Hardware event]
cache-misses                  [Hardware event]
branch-instructions OR branches [Hardware event]
[...]
  skb:kfree_skb                [Tracepoint event]
  skb:consume_skb              [Tracepoint event]
  skb:skb_copy_datagram_iovec  [Tracepoint event]
  net:net_dev_xmit             [Tracepoint event]
  net:net_dev_queue           [Tracepoint event]
  net:netif_receive_skb       [Tracepoint event]
  net:netif_rx                 [Tracepoint event]
[...]
  block:block_rq_abort        [Tracepoint event]
  block:block_rq_requeue      [Tracepoint event]
  block:block_rq_complete     [Tracepoint event]
  block:block_rq_insert       [Tracepoint event]
  block:block_rq_issue        [Tracepoint event]
  block:block_bio_bounce      [Tracepoint event]
  block:block_bio_complete    [Tracepoint event]
[...]
```

perf_events: Tracing Tracepoints

```
# perf record -e block:block_rq_complete -a sleep 10
[ perf record: Woken up 1 times to write data ]
[ perf record: Captured and wrote 0.428 MB perf.data (~18687 samples) ]
# perf script
    run 30339 [000] 2083345.722767: block:block_rq_complete: 202,1 W () 12984648 + 8 [0]
    run 30339 [000] 2083345.722857: block:block_rq_complete: 202,1 W () 12986336 + 8 [0]
    run 30339 [000] 2083345.723180: block:block_rq_complete: 202,1 W () 12986528 + 8 [0]
  swapper    0 [000] 2083345.723489: block:block_rq_complete: 202,1 W () 12986496 + 8 [0]
  swapper    0 [000] 2083346.745840: block:block_rq_complete: 202,1 WS () 1052984 + 144 [0]
supervise 30342 [000] 2083346.746571: block:block_rq_complete: 202,1 WS () 1053128 + 8 [0]
supervise 30342 [000] 2083346.746663: block:block_rq_complete: 202,1 W () 12986608 + 8 [0]
    run 30342 [000] 2083346.747003: block:block_rq_complete: 202,1 W () 12986832 + 8 [0]
[...]
```

- If -g is used in "perf record", stack traces are included
- If "perf script" output is too verbose, try "perf report", or making a flame graph

BPF

- Enhanced Berkeley Packet Filter, now just "BPF"
 - Enhancements added in Linux 3.15, 3.19, 4.1, 4.5, ...
- Provides programmatic tracing
 - measure latency, custom histograms, ...

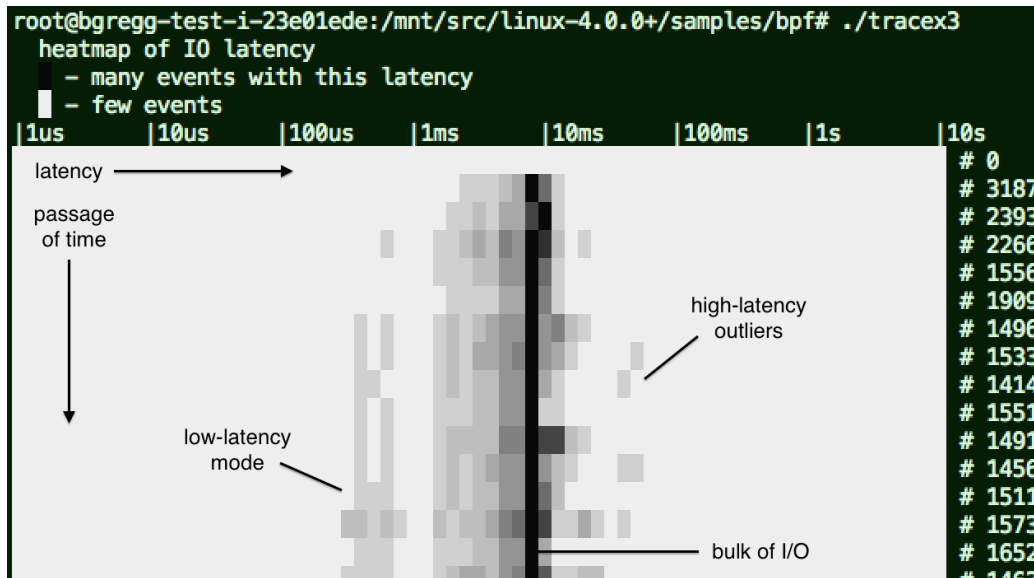

System dashboards of 2017+ should look very different

BPF: bcc ext4slower

- ext4 operations slower than the threshold:

```
# ./ext4slower 1
Tracing ext4 operations slower than 1 ms
TIME          COMM          PID      T BYTES    OFF_KB    LAT(ms)  FILENAME
06:49:17 bash          3616     R 128      0          7.75     cksum
06:49:17 cksum        3616     R 39552    0          1.34     [
06:49:17 cksum        3616     R 96       0          5.36     2to3-2.7
06:49:17 cksum        3616     R 96       0         14.94     2to3-3.4
06:49:17 cksum        3616     R 10320    0          6.82     411toppm
06:49:17 cksum        3616     R 65536    0          4.01     a2p
06:49:17 cksum        3616     R 55400    0          8.77     ab
06:49:17 cksum        3616     R 36792    0         16.34     aclocal-1.14
06:49:17 cksum        3616     R 15008    0         19.31     acpi_listen
[...]
```

- Better indicator of application pain than disk I/O
- Measures & filters in-kernel for efficiency using BPF
 - <https://github.com/iovisor/bcc>

BPF: bcc tools (early 2016)

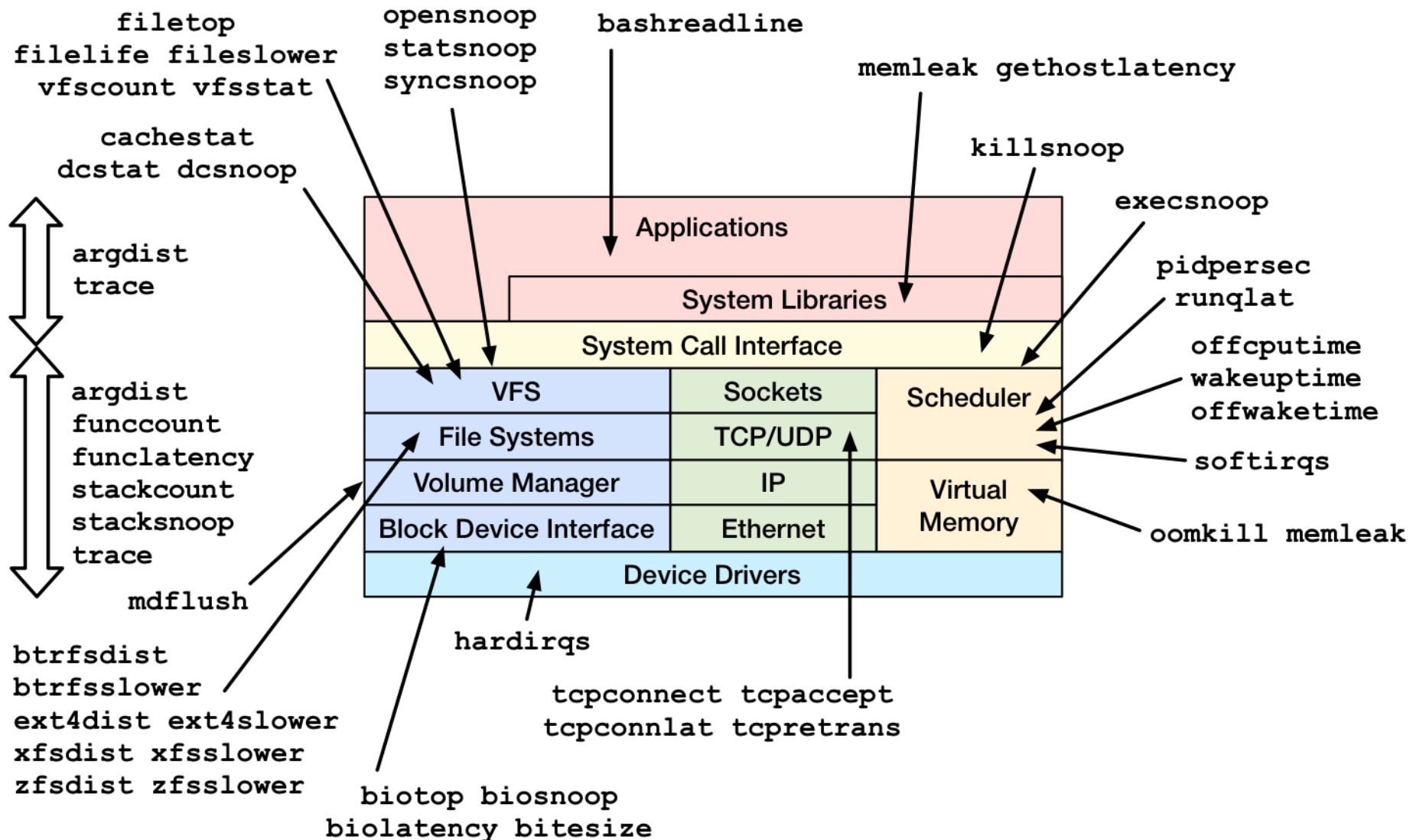

6. Tuning

Ubuntu Trusty Tuning: Early 2016 (1/2)

- CPU

```
    schedtool -B PID
```

```
    disable Ubuntu apport (crash reporter)
```

```
    also upgrade to Xenial (better HT scheduling)
```

- Virtual Memory

```
    vm.swappiness = 0          # from 60
```

```
    kernel.numa_balancing = 0 # temp workaround
```

- Huge Pages

```
    echo never > /sys/kernel/mm/transparent_hugepage/enabled
```

- File System

```
    vm.dirty_ratio = 80          # from 40
```

```
    vm.dirty_background_ratio = 5 # from 10
```

```
    vm.dirty_expire_centisecs = 12000 # from 3000
```

```
    mount -o defaults,noatime,discard,nobarrier ...
```

- Storage I/O

```
    /sys/block/*/queue/rq_affinity      2
```

```
    /sys/block/*/queue/scheduler        noop
```

```
    /sys/block/*/queue/nr_requests      256
```

Ubuntu Trusty Tuning: Early 2016 (2/2)

- Storage (continued)

```
/sys/block/*/queue/read_ahead_kb 256  
mdadm --chunk=64 ...
```

- Networking

```
net.core.somaxconn = 1000  
net.core.netdev_max_backlog = 5000  
net.core.rmem_max = 16777216  
net.core.wmem_max = 16777216  
net.ipv4.tcp_wmem = 4096 12582912 16777216  
net.ipv4.tcp_rmem = 4096 12582912 16777216  
net.ipv4.tcp_max_syn_backlog = 8096  
net.ipv4.tcp_slow_start_after_idle = 0  
net.ipv4.tcp_tw_reuse = 1  
net.ipv4.ip_local_port_range = 10240 65535  
net.ipv4.tcp_abort_on_overflow = 1 # maybe
```

- Hypervisor (Xen)

```
echo tsc > /sys/devices/.../current_clocksource  
Plus PVHVM (HVM), SR-IOV, ...
```

Summary

A brief discussion of 6 facets of Linux performance:

1. Observability
2. Methodologies
3. Benchmarking
4. Profiling
5. Tracing
6. Tuning

Takeaways

Some things to print out for your office wall:

1. `uptime`
2. `dmesg -T | tail`
3. `vmstat 1`
4. `mpstat -P ALL 1`
5. `pidstat 1`
6. `iostat -xz 1`
7. `free -m`
8. `sar -n DEV 1`
9. `sar -n TCP,ETCP 1`
10. `top`

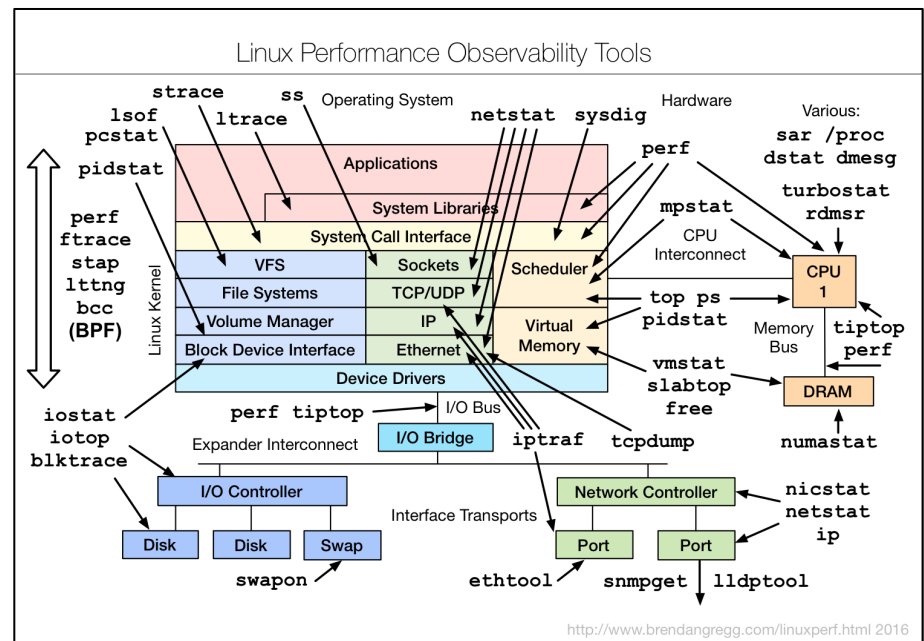

More Links

- Netflix Tech Blog on Linux:
 - <http://techblog.netflix.com/2015/11/linux-performance-analysis-in-60s.html>
 - <http://techblog.netflix.com/2015/08/netflix-at-velocity-2015-linux.html>
- Linux Performance:
 - <http://www.brendangregg.com/linuxperf.html>
- Linux perf_events:
 - https://perf.wiki.kernel.org/index.php/Main_Page
 - <http://www.brendangregg.com/perf.html>
- Linux ftrace:
 - <https://www.kernel.org/doc/Documentation/trace/ftrace.txt>
 - <https://github.com/brendangregg/perf-tools>
- USE Method Linux:
 - <http://www.brendangregg.com/USEmethod/use-linux.html>
- Flame Graphs:
 - <http://www.brendangregg.com/FlameGraphs/cpuflamegraphs.html>



PERCONA
LIVE

Thanks

- Questions?
- <http://slideshare.net/brendangregg>
- <http://www.brendangregg.com>
- bgregg@netflix.com
- [@brendangregg](https://twitter.com/brendangregg)

